

42" H x 30" W x 16" D 1 DOOR DESIGN

NEMA 4X - ENCLOSURE
ELECTRICAL CABINET
FLOOR MOUNT



FILE NUMBER: E507642

STAINLESS STEEL

ENCLOSURE MATERIAL

- 304 STAINLESS STEEL (S4)
- 316 STAINLESS STEEL (S6)

POWDERCOAT COLOR

- STANDARD WHITE
- LIGHT GRAY ANSI 70
- DARK GRAY ANSI 61
- STANDARD BLACK
- CUSTOM _____

FLOOR KIT

- 6" HT. (STANDARD)
- 8" HT.
- 10" HT.
- 12" HT.
- CUSTOM _____

FLOOR KIT OPTIONS

- FIXED FLOOR KIT
- REMOVABLE FLOOR KIT

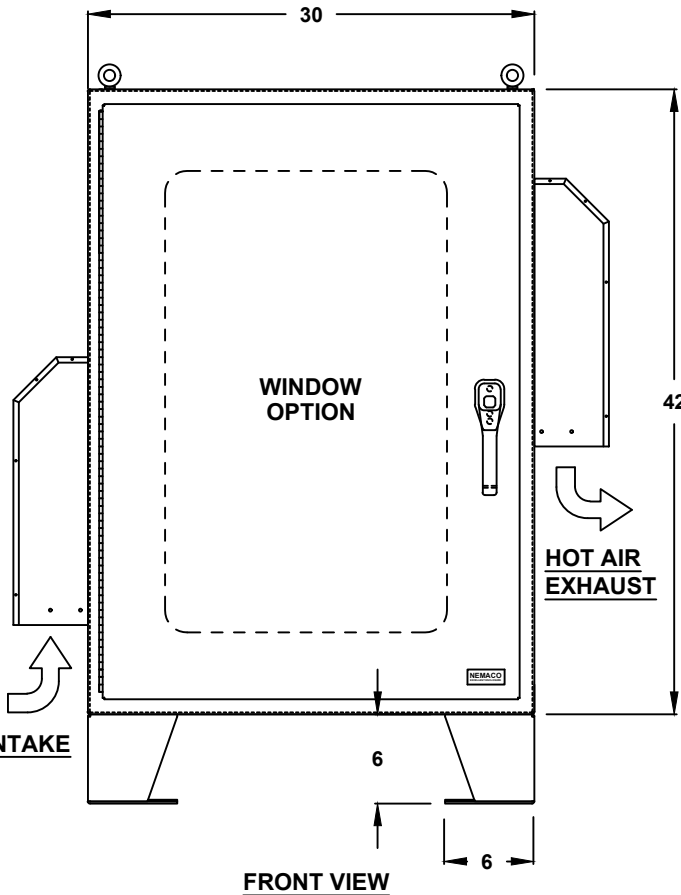

LIFTING EYE

- WELDED PADS (STANDARD)
- REMOVABLE PADEYES

DOOR HINGE

- PIANO HINGE
- LIFT OFF HINGE

DOOR LATCH OPTIONS

- 3 PT. LATCH (STANDARD)
- CLAMP SCREW WITH HASP

DOOR HANDLE

- PADLOCK PROVISION (STANDARD)
- KEYLOCK (OPTION)

*WINDOW OPTIONS

- TEMPERED GLASS
- NOT REQUIRED

*NOTE: UL & NON-UL OPTIONS AVAILABLE

ALL DIMENSIONS ARE ESTIMATED IN INCHES AND MAY VARY DUE TO SELECTED OPTIONS.

COMPANY NAME _____

APPROVED (PRINTED NAME) _____

SIGNATURE _____

DATE _____

42" H x 30" W x 16" D 1 DOOR DESIGN

THERMAL SPECIFICATIONS

- OUTSIDE (AMBIENT) _____ °F
- INTERIOR TEMP. _____ °F
- HEAT LOAD (WATTS) _____
- SUN / SHADE _____

FAN SERIES

- 60FL SERIES, 18" H (40-92 CFM)
- 180FL SERIES, 24"H (177-179 CFM)
- 225FL SERIES, 24"H (350 CFM)

FAN MATERIALS

- BAKED POWDER STEEL
- STAINLESS STEEL

FAN SYSTEM

- PUSH-PULL SYSTEM (STANDARD)
- PUSH SYSTEM
- PULL SYSTEM
- NOT REQUIRED

FAN VOLTAGE/ HZ

- 115/60 (STANDARD)
- 230/60
- 12 VDC
- 24 VDC
- 48 VDC
- SPECIFY _____

ACCESSORIES AND OPTIONS

- REPLACEMENT FILTER

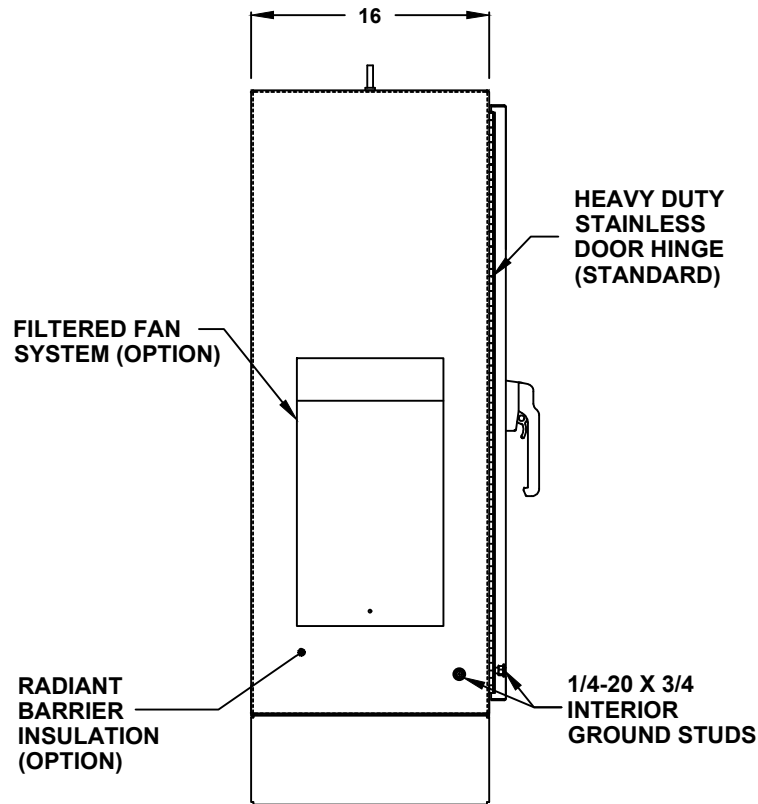

LEFT SIDE

SUN REFLECTIVE SOLUTION

- TOP SUNSHIELD COVER

ENCLOSURE INSULATION

- 1/2 RADIANT BARRIER (STANDARD)
- 3/4 RADIANT BARRIER
- 1 RADIANT BARRIER
- NOT REQUIRED

FAN SERVICE DOOR

- FAN SERVICE DOOR
- NOT REQUIRED

ENCLOSURE INSULATION

- 1/2 RADIANT BARRIER (STANDARD)
- 3/4 RADIANT BARRIER
- 1 RADIANT BARRIER
- NOT REQUIRED

42" H x 30" W x 16" D 1 DOOR DESIGN

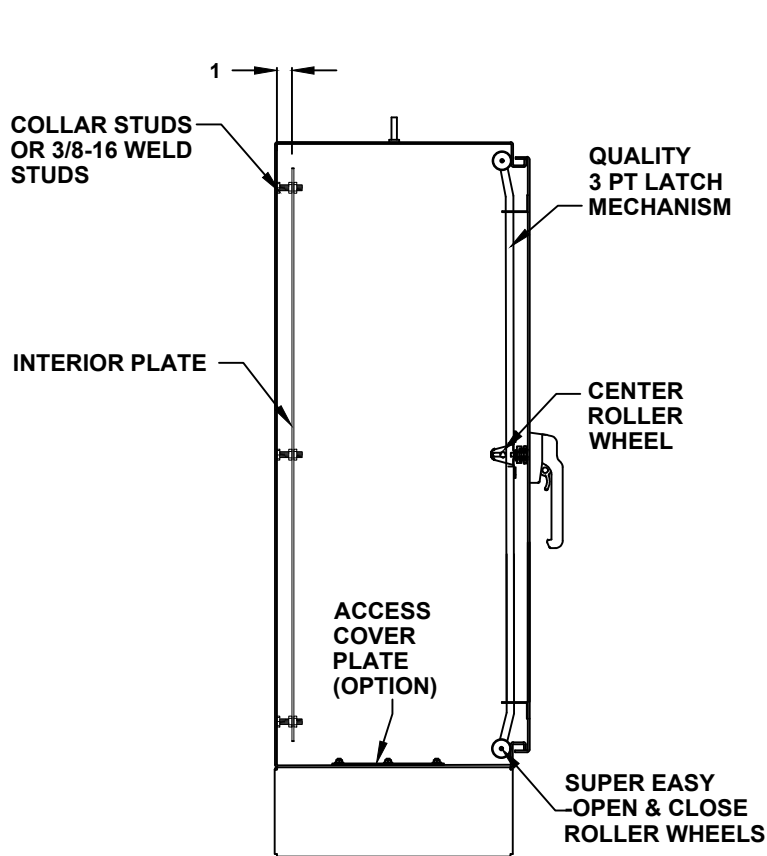

CROSS SECTION VIEW A-A

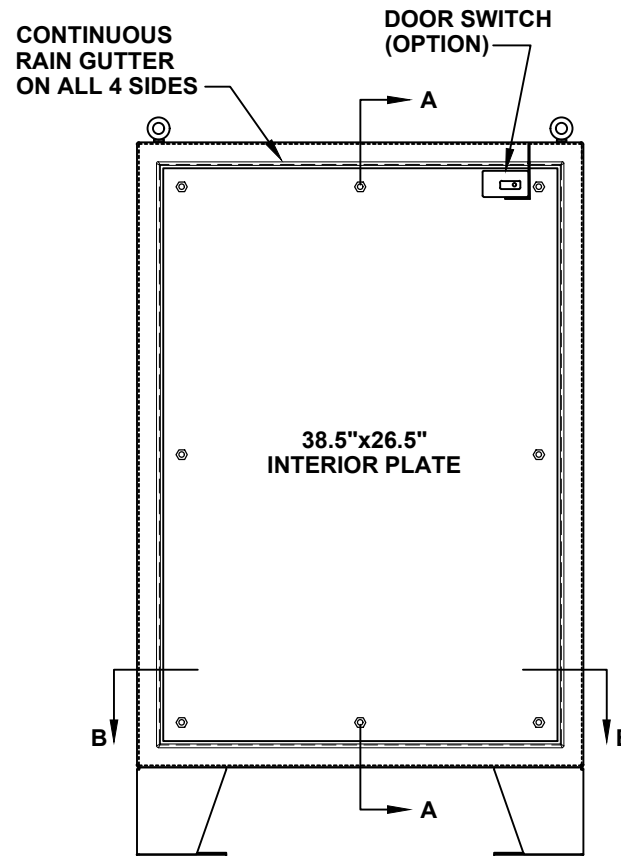

FRONT VIEW WITH DOOR REMOVED

DOOR ACCESSORIES

- DOOR SWITCH
- PRINT POCKET

INTERIOR PLATE

- COATED STEEL (IP4230-CS)
- COATED ALUMINUM (IP4230-AL)
- 304 STAINLESS STEEL (IP4230-S4)
- 316 STAINLESS STEEL (IP4230-S6)

42" H x 30" W x 16" D 1 DOOR DESIGN

- DOOR STOPPER**
- INSTALL DOOR STOPPER
 - NOT REQUIRED

**BASE ACCESS COVER PLATE
(OPTION)**

- 8x8 PLATE (6x6 CUT-OUT)
- 8x16 PLATE (6x14 CUT-OUT)
- 12x12 PLATE (10x10 CUT-OUT)
- 16x16 PLATE (14x14 CUT-OUT)

CONDUIT/CABLE SEAL OPTIONS

- ROXTEC SEAL SOLUTION
- PIPE FITTING HUB
- CABLE GLAND

SIDE ACCESS COVER PLATE MAT'L

- POWDER COATED STEEL
- POWDER COATED ALUMINUM
- STAINLESS STEEL, 304

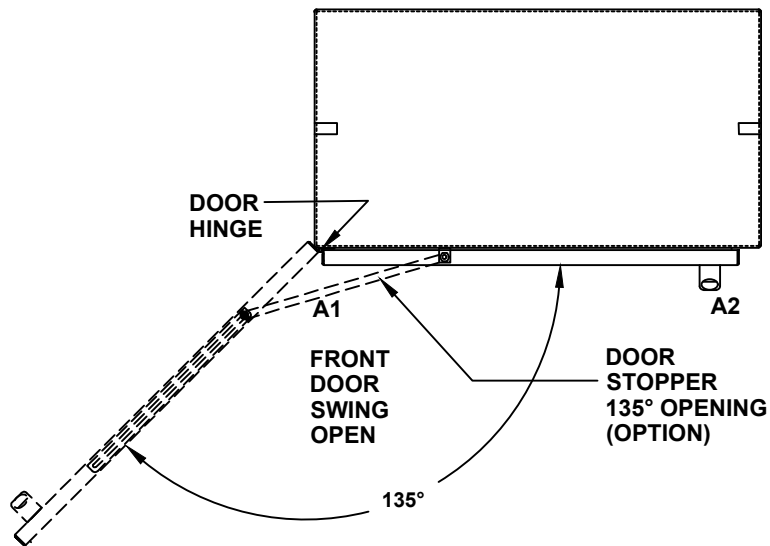

TOP VIEW

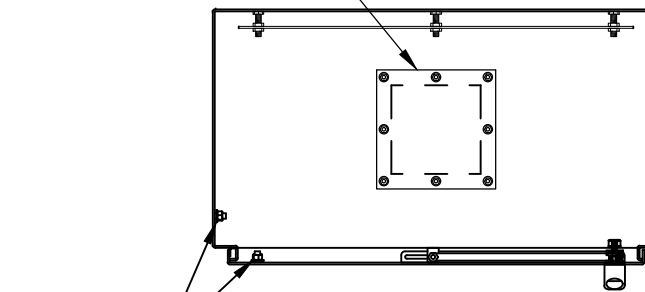

- 1/4-20 X 3/4
INTERIOR
GROUND STUDS
- BONDING STRAPS

**QUAD OUTLET BOX
ON 8x8 PLATE (OPTION)**

- ADD QUAD BOX
- 15A 115V RECEPTACLE
- 20A 115V RECEPTACLE
- NOT REQUIRED

TOP CROSS SECTION VIEW B-B

42" H x 30" W x 16" D 1 DOOR DESIGN

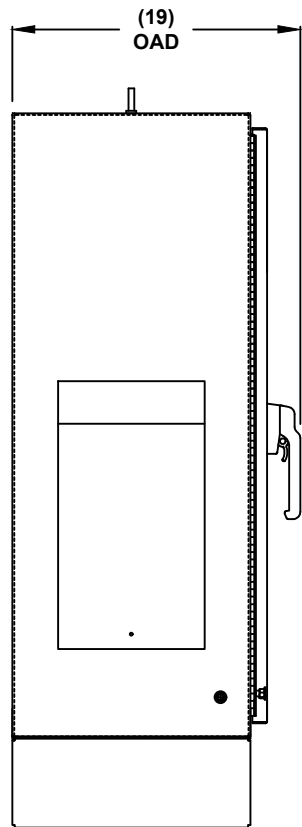

LEFT SIDE

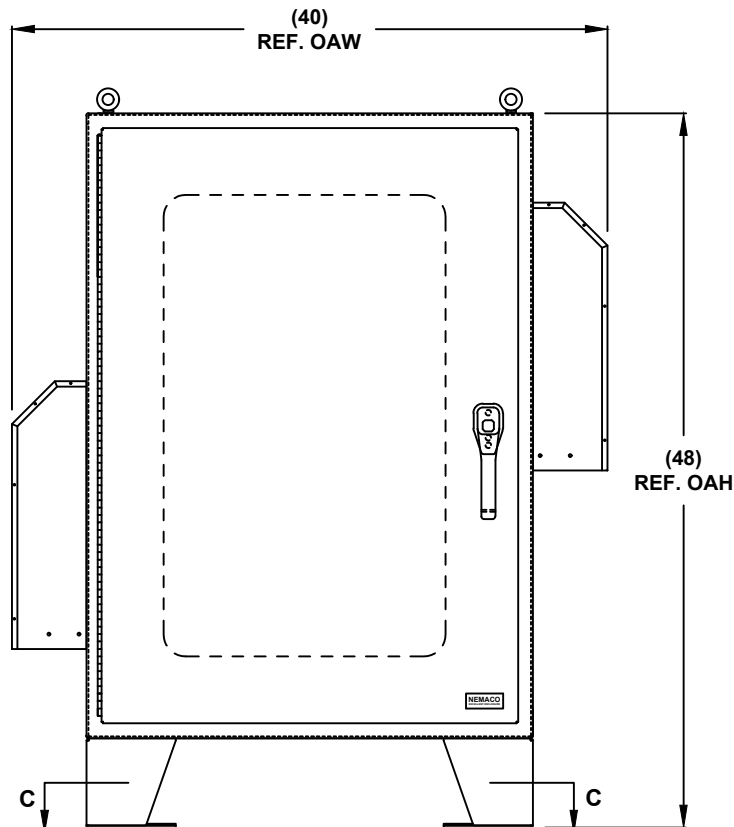

FRONT VIEW

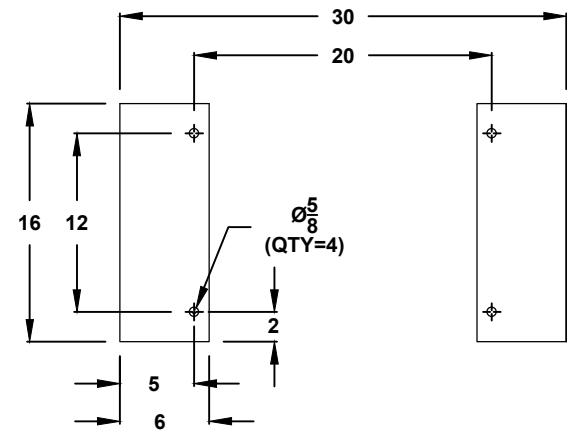

CROSS SECTION VIEW C-C
MOUNTING HOLES